

# SYSTEM M

## ABMESSUNGEN

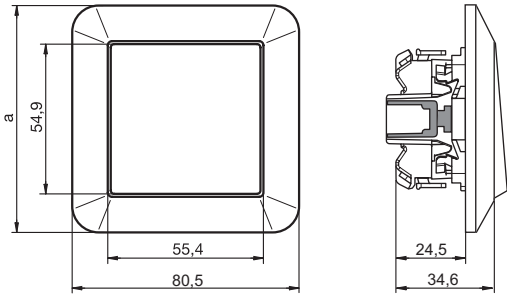

### Wippschalter QuickFlex



1-M

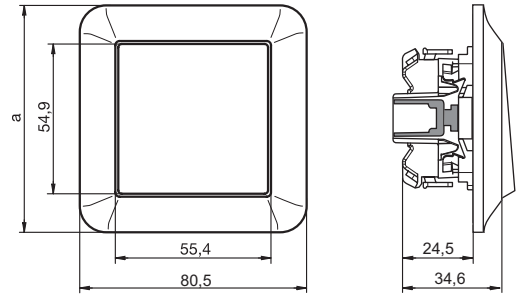

ATELIER-M

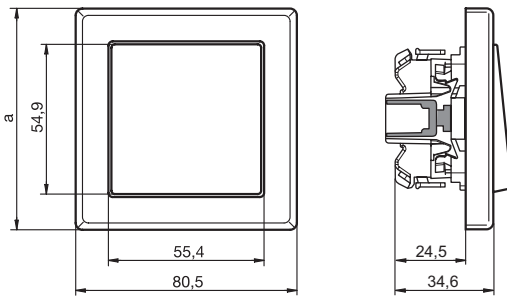

M-SMART

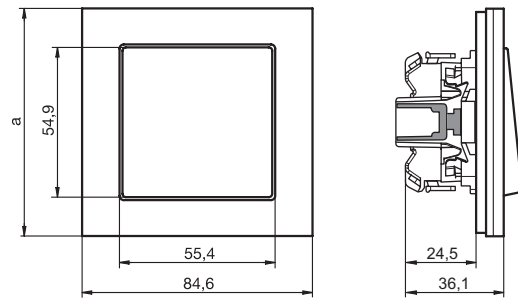

M-ARC

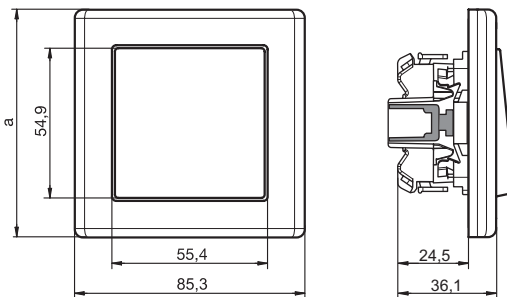

M-STAR

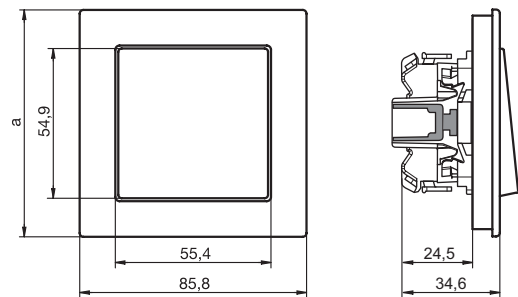

M-PLAN

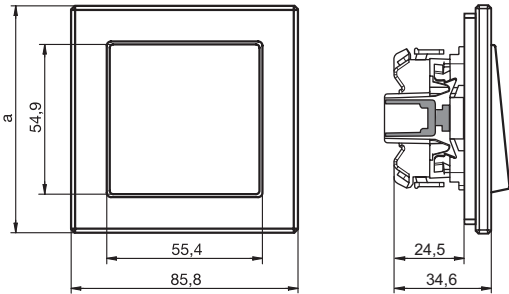

M-PLAN Metall

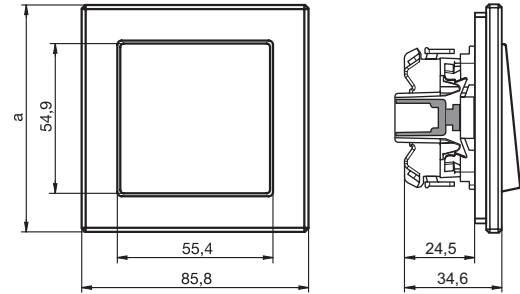

M-PLAN Echtglas

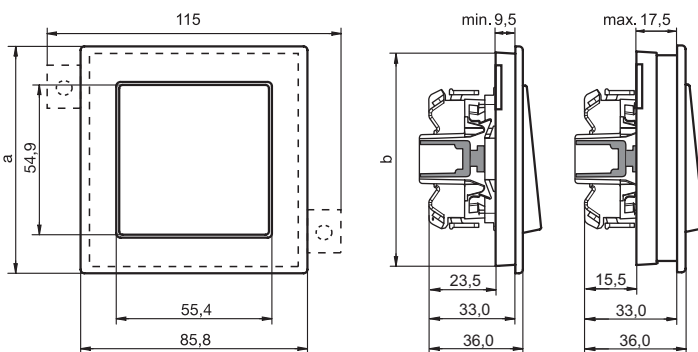

M-PLAN II

System M	1fach	2fach	3fach	4fach	5fach
1-M	a=80,5	a=151,7	a=222,9	a=294,1	a=365,3
ATELIER-M	a=80,5	a=151,7	a=222,9	a=294,1	a=365,3
M-SMART	a=80,5	a=151,7	a=222,9	a=294,1	a=365,3
M-ARC	a=83,4	a=154,6	a=225,8	a=297	a=368,2
M-STAR	a=83,9	a=155	a=226,2	a=297,4	a=368,6
M-PLAN	a=83,4	a=154,6	a=225,8	a=297	a=368,2
M-PLAN II	a=83,4 b=80,0	a=154,6 b=151,2	a=225,8 b=222,4		
M-PLAN-Echtglas	a=85,8	a=157,0	a=228,2	a=299,4	a=370,6
M-PLAN-Metall	a=85,8	a=157,0	a=228,2	a=299,4	a=370,6

System M IP44	1fach	2fach	3fach	4fach	5fach
M-SMART	a=80,5	a=151,7	a=222,9	a=294,1	a=365,3
M-ARC	a=83,4	a=154,6	a=225,8	a=297	a=368,2
M-PLAN	a=83,4	a=154,6	a=225,8	a=297	a=368,2



Der runde Schalter

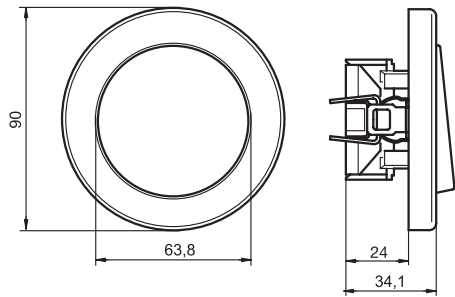

Der runde Schalter ist ein Komplettgerät. Wenn Sie eine Mehrfachkombination realisieren wollen, dann muss der Abstand zwischen Dosenmitte zu Dosenmitte 113 mm betragen.

Empfehlung: Den Abstand erreichen Sie, indem Sie z. B. zwei Abstandsstützen von je 21 mm Länge zwischen die UP-Dosen setzen.

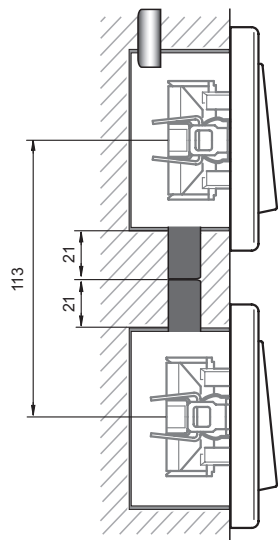

Jumbo, der große Schalter

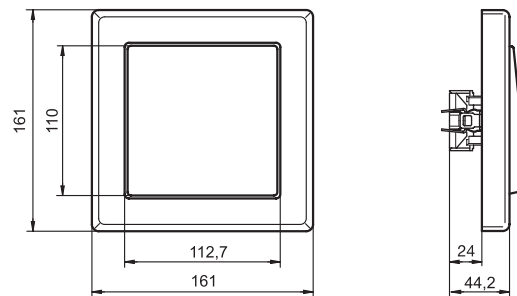
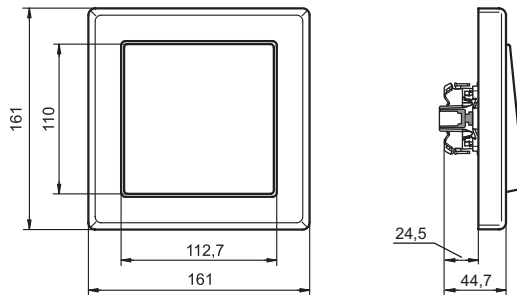

Rasiersteckdose

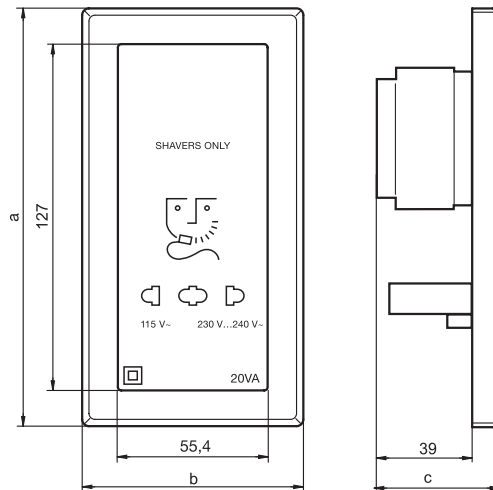

System M	a	b	c
M-SMART	151,7	80,5	49,1
M-ARC	154,6	84,6	50,6
M-STAR	155	85,3	50,6
M-PLAN	154,6	85,8	49,1
M-PLAN-Echtglas	157	85,8	49,1